



PRORACK

Powered by PROLINK

We provide customers with satisfactory products and services according to international standards, to meet different customer needs.



Description:

 Wall mount cabinet with glass door, 1 fan, 1 shelf and 1 PDU 8 outlet.

Main material:

 Cold-rolled steel









Load capacity:

 Static load: 800KG

Surface treatment:

 Degreasing, pickling, phosphating, laundering, powder coating

Features:

-  Exquisite design with precise dimensions and craftsmanship
-  Two side panels for each side can be separately open with locks, which are easy to operation and maintenance
-  Two back sides with multifunctional cable routing panels
-  High-class locks
-  Casters and support feet can be installed simultaneously
-  Optional pedestals for fixation, cable routing, ventilation, and rat proof
-  Curved front screen door & back double screen door enable equipment to ventilate well
-  Various optional accessories
-  Pro-Rack logo is printed on the side panel

Structure

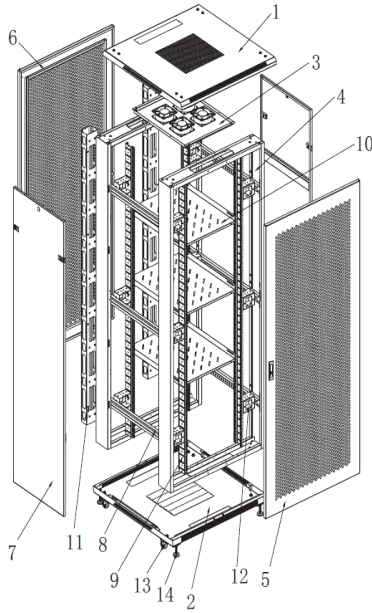

- 1. Top cover
- 2. Bottom plate
- 3. Fans
- 4. Frame
- 5. Front door
- 6. Back door
- 7. Side panel
- 8. Horizontal bracket
- 9. Profile rails
- 10. Shelf
- 11. Caster
- 12. Support foot

Size

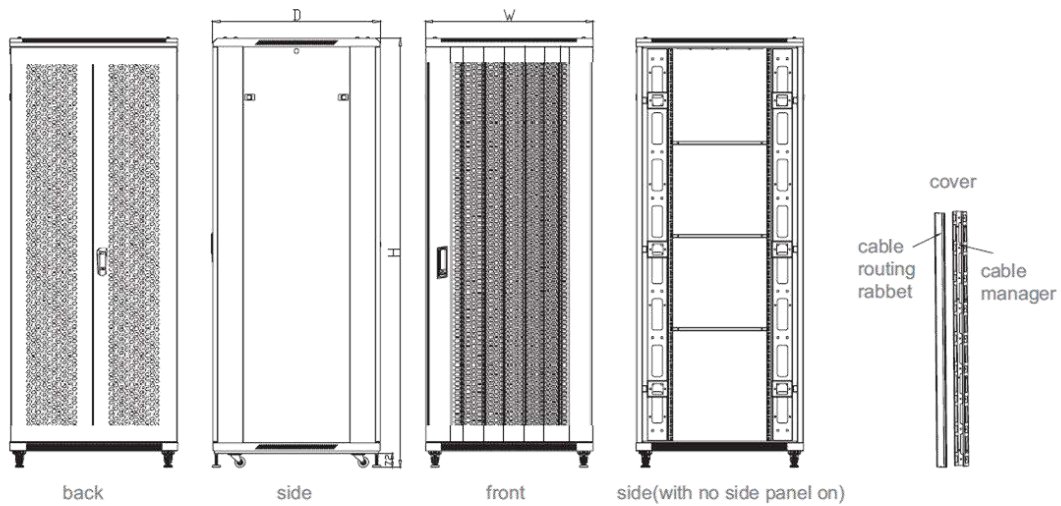

Installing

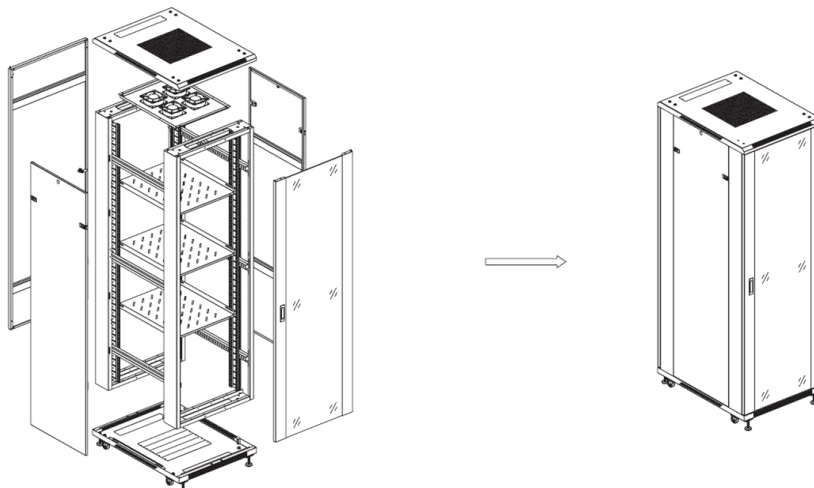
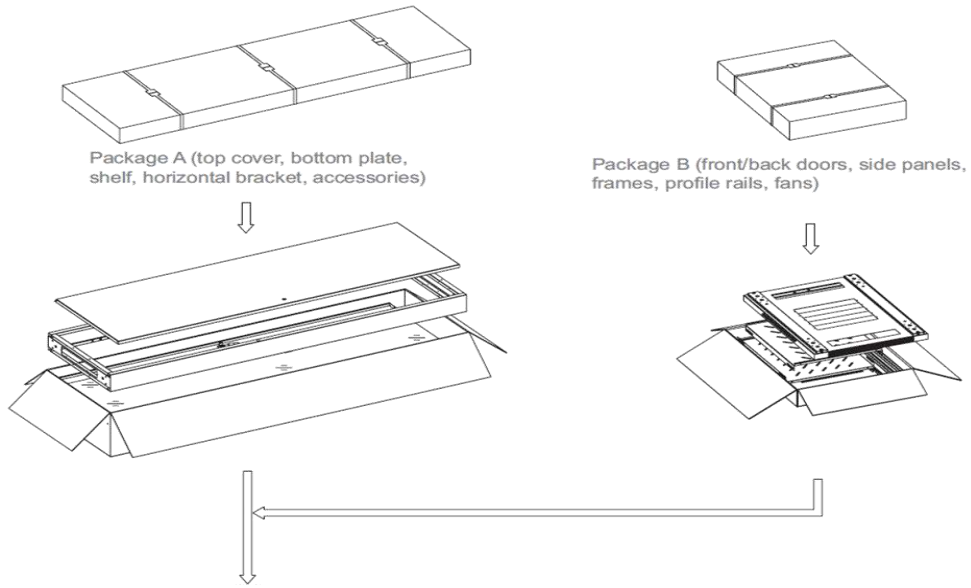

Technical parameters:

NANES	QUANTITY	UNIT	MATERIALS	SURFACE TREATMENT	REMARKS
Top Covers	1	Pc	1.2mm cold-rolled steel	powder coating	
Bottom plates	1	Pc	1.2mm cold-rolled steel	powder coating	
Fans	1	Pc	1.2mm cold-rolled steel	powder coating	
Frames	2	Pc	1.2mm cold-rolled steel	powder coating	
Front doors	1	Pc	5mm tempered glasses 1.2mm cold-rolled quality steel	powder coating	door type E or B
Back doors	1	Pc	1.2mm cold-rolled steel	powder coating	door type K
Side panels	2	Pc	1.0mm cold-rolled steel	powder coating	
Rails	4	Pc	2.0mm cold-rolled steel	powder coating	
Shelves	1	Pc	1.2mm cold-rolled steel	powder coating	
Casters	4	Pc			
M12 support feet	4				
Cage nuts	40				
Sockets with 8 outlet	1				
Beams	6	Pc	1.2mm cold-rolled steel	powder coating	
Junction boxes	12	Pc	2.0mm cold-rolled steel		

TYPES	PR-FG618
CAPACITY (U)	18U
WIDTH	600
DEPTH	600
HEIGHT	988
WHOLE PACKAGE	
WIDTH	620
DEPTH	620
HIGHT	1000
VOLUME (M ³)	0.384
FLAT PACKAGE	
PACKAGE A	920*620*320
PACKAGE B	620*620*130
VOLUMES (M ³)	0.233
Front Door	Glass

Color:

 **BLACK (RAL9005)**