

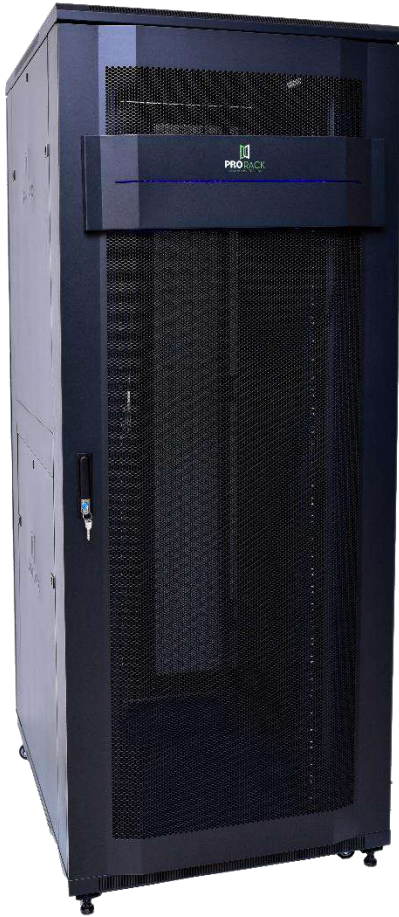



PRORACK

Powered by PROLINK

We provide customers with satisfactory products and services according to international standards, to meet different customer needs.



Discription

 Standing network rack with vented door, 4 fans, 1 shelf and 1 PDU 8 outlet

Main material:

 Cold-rolled steel









Load capacity:

 Static load: 800KG

Surface treatment:

 Degreasing, pickling, phosphating, laundering, powder coating

Features:

-  Exquisite design with precise dimensions and craftsmanship
-  Two side panels for each side can be separately open with locks, which are easy to operation and maintenance
-  Two back sides with multifunctional cable routing panels
-  High-class locks
-  Casters and support feet can be installed simultaneously
-  Optional pedestals for fixation, cable routing, ventilation, and rat proof
-  Curved front screen door & back double screen door enable equipment to ventilate well
-  Various optional accessories
-  Pro-Rack logo is printed on the side panel

Structure

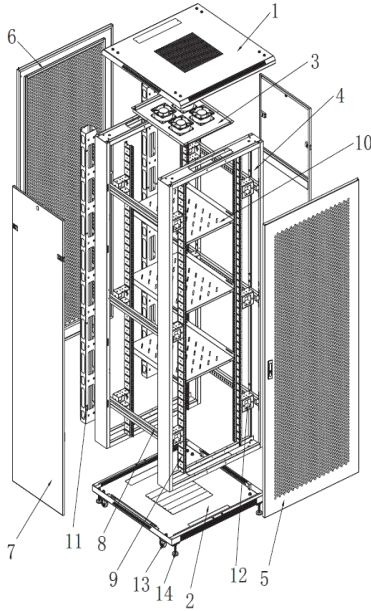

1. Top cover
2. Bottom plate
3. Fans
4. Frame
5. Front door
6. Back door
7. Side panel
8. Horizontal bracket
9. Profile rails
10. Shelf
11. Caster
12. Support foot

Size

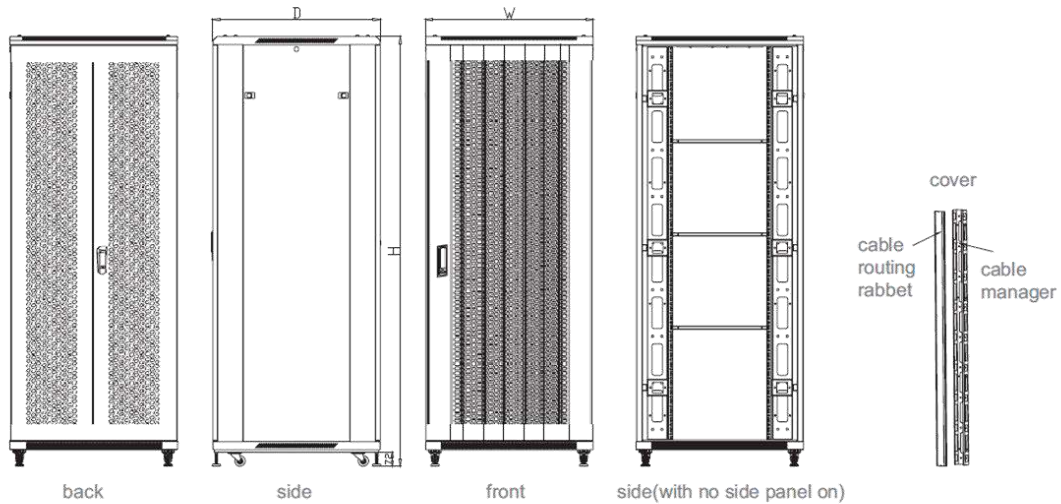

Installing

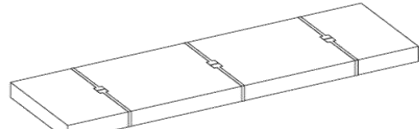

Package A (top cover, bottom plate, shelf, horizontal bracket, accessories)

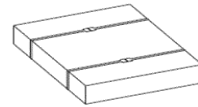

Package B (front/back doors, side panels, frames, profile rails, fans)

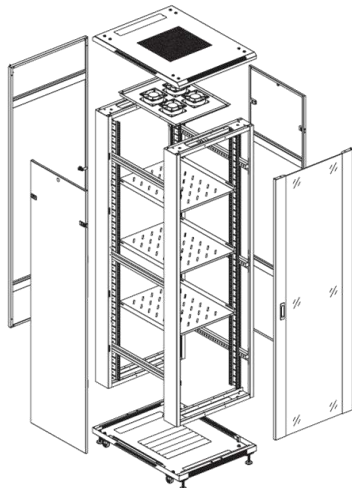
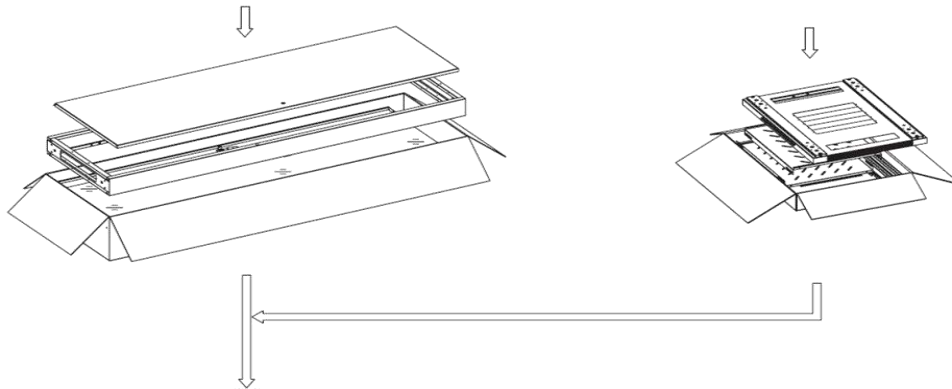

Technical parameters:

NANES	QUANTITY	UNIT	MATERIALS	SURFACE TREATMENT	REMARKS
Top Covers	1	Pc	1.2mm cold-rolled steel	powder coating	
Bottom plates	1	Pc	1.2mm cold-rolled steel	powder coating	
Fans	4	Pc	1.2mm cold-rolled steel	powder coating	
Frames	2	Pc	1.2mm cold-rolled steel	powder coating	
Front doors	1	Pc	5mm tempered glasses 1.2mm cold-rolled quality steel	powder coating	door type E or B
Back doors	1	Pc	1.2mm cold-rolled steel	powder coating	door type K
Side panels	2	Pc	1.0mm cold-rolled steel	powder coating	
Rails	4	Pc	2.0mm cold-rolled steel	powder coating	
Shelves	1	Pc	1.2mm cold-rolled steel	powder coating	
Casters	4	Pc			
M12 support feet	4				
Cage nuts	40				
Sockets with 8 outlet	1				
Beams	6	Pc	1.2mm cold-rolled steel	powder coating	
Junction boxes	12	Pc	2.0mm cold-rolled steel		

TYPES	PR-FV6127
CAPACITY (U)	27U
WIDTH	600
DEPTH	1000
HEIGHT	1388
WHOLE PACKAGE	
WIDTH	620
DEPTH	1020
HIGHT	1398
VOLUME (M ³)	0.884
FLAT PACKAGE	
PACKAGE A	1320*620*320
PACKAGE B	1020*620*130
PACKAGE C	
VOLUMES (M ³)	0.344
Front Door	Vented

Color:

 **BLACK (RAL9005)**